

Pushing the Limits of Gravity Separation

Claude Deveau, Cabot Supermetals, Bernic Lake, Manitoba, Can

Stephen R. Young, Cabot Supermetals, Bernic Lake, Manitoba, Can

Introduction

Tanco History

Tanco is sometimes known as the Bernic Lake Mine. It is located about 180 km east-northeast of Winnipeg close to the Manitoba-Ontario boundary. Tanco operates an underground mine employing ramp access, room and pillar mining and shaft hoisting for the production of tantalum, lithium and cesium minerals. Tantalum recovery employs conventional gravity and centrifugal concentration methods along with a flotation process which recovers ultra-fine tantalum. All tantalum concentrates are shipped to Cabot Supermetals, Boyertown, Pa., for the production of tantalum chemicals and metals. Tanco also produces lithium products from spodumene ore. The lithium concentrates from Tanco are shipped worldwide for use in ceramics, specialty glass and mold powders. Cesium processing involves the dry grinding of pollucite as feed stock to the on-site chemical plant dedicated to the production of cesium formate, a high density drilling fluid.

Tantalum milling operations commenced in 1969. In the early years of the operation, feed grades were three to four times as high as they are today. Coarse-grained tantalum mineralization with complete tantalum liberation at sizes of 300 μm allowed for easy recovery with conventional equipment such as spirals and shaking tables. Over the years, the process and feed material to the plant have drastically changed. Due to drastically reduced liberation sizes, efforts have been made to try to recover as much of the liberated particles as possible in order to maintain acceptable recoveries. This has driven projects such as the installation of Falcon continuous concentrators which scavenge the majority of the plant's conventional gravity equipment rejects. A Linatex hydrosizer was also installed within the grinding circuit in order to improve grinding circuit classification and to reduce the production of irrecoverable ultra-



Figure 1. Aerial view of Tanco Mine on Bernic Lake.

fine tantalum. The Linatex hydrosizer replaced Derrick screens along with 10" Krebs cyclones. The cyclone treated the Derrick screen oversize in an effort to reduce misplaced fines. The addition of the Linatex hydrosizer seen in Figure 2, reduced



Figure 2. Linatex hydrosizer (blue)

misplaced material passing 300 μm returning to the ballmill from approximately 40% down to between 4 and 7%. The grinding circuit product remained essentially the same.

In the fall of 2002, a flotation circuit was installed at Tanco. This process targeted the finest material in the Tanco flowsheet. Tantalum flotation at Tanco proved to be very efficient with a float circuit feed of 4 mt/hr being reduced to a 200 kg/hr concentrate stream containing at times over 90% of the tantalum. Prior to the design and commissioning of the flotation circuit, extensive investigations were completed on making use of flotation as a cleaner to the initial stage of flotation. Attempts were unsuccessful in providing any additional concentration to the initial flotation concentrate.

Historically, tantalum flotation concentrate had been treated with Bartles crossbelt concentrators at Tanco (1980) shown in Figure 3. This type of concentrator is basically an oversized vanner with a moving belt as a concentrating surface. With Tanco's knowledge of centrifugal concentrators coupled with the persistent nature of the tantalum flotation froth, it was decided that



Figure 3. Bartles crossbelt concentrator.

the cross belt would not be the best candidate for treating the flotation circuit concentrate. Due to the voluminous nature of froth, the low throughput and the fine nature of the tantalum to be recovered, the Mozley Multi-Gravity Separator 900 (MGS) was selected as a cleaner for the flotation concentrate. The MGS 900 was installed as the clean for the tantalum flotation circuit. The tailings from the MGS 900 were piped back to the flotation feed conditioner in order to close the cleaner stage of the circuit.

Circuit commissioning and findings

It was rapidly found during commissioning that this configuration would not be successful. Even though it is specified that the MGS 900 could successfully treat up to 200 kg/hr, this would not be the case with such a fine and low density stream. Flotation concentrate averaged between 4 – 7 % solids with a tantalum distribution as shown in Figure 4.

Pilot tests with the MGS 900 at much lower throughputs had provided far better

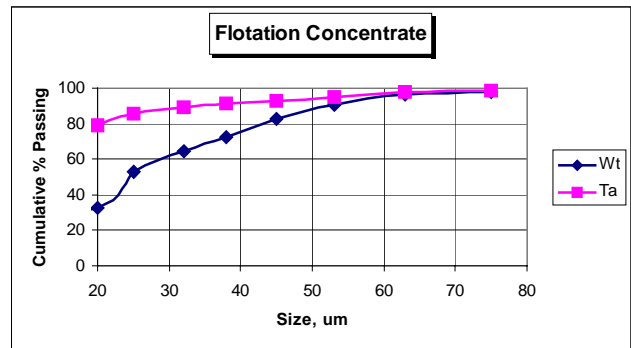

Figure 4. Tantalum flotation concentrate weight and tantalum distribution.

results than the ones generated on full scale operation. Initial performance results can be seen in Figure 5. Concentrate grade produced with this type of performance was acceptable. With the MGS 900's inability to recover a large quantity of tantalum in the finer size fractions and the flotation circuit's ability to recover it, a large circulating load of very fine tantalum was promptly set up. This created froth problems with the circuit pumps and launders.

In an effort to eliminate these problems, the circulating load was broken by allowing the MGS 900 reject to the plant's tailings instead of back to the flotation circuit. This improved the situation however the low density feed to the MGS 900 was still a concern with respect to MGS 900 performance. The MGS 900 owner's manual recommends a feed density of 10 – 50% solids, it was felt that the density of the slurry feeding the MGS 900 should be closer to the middle of the range than slightly below it due to the net volume of slurry. Two pairs of 2" Mozley cyclones were installed in order to dewater the flotation concentrate prior to

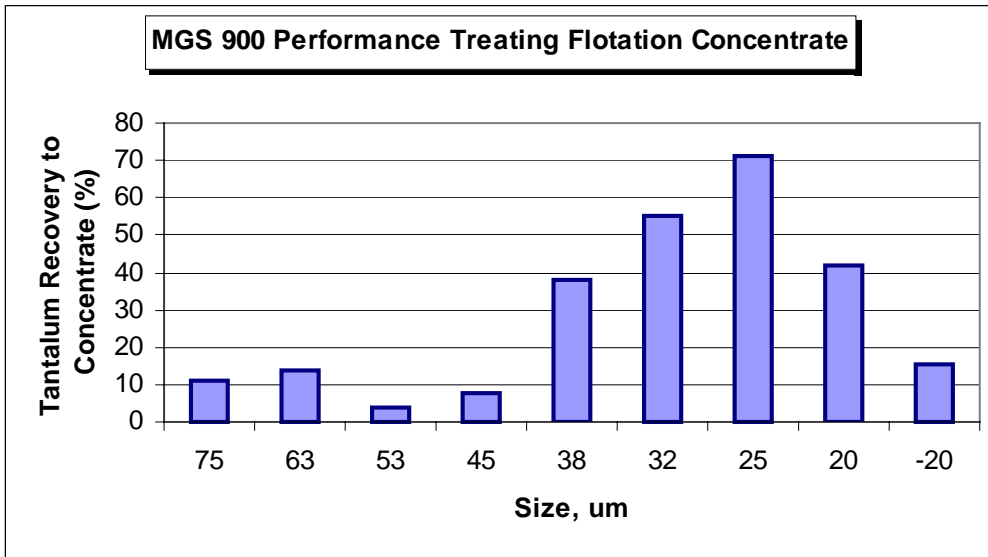

Figure 5. Size by size tantalum recovery of MGS 900.

feeding the MGS 900. 85-90% of the tantalum reported to cyclone underflow. This also produced feed densities in the 35% solids range for the MGS 900. The overall tantalum recovery improved from 15% to 30% and the tantalum recovery by size also improved as seen in Figure 6. Enrichment however, dropped from 7.15 to 5.28.

investigated were: drum rotational speed, wash-water addition, drum tilt angle, stroke length, amplitude and feed tonnage. These tests were completed by adjusting one parameter at a time while all other variables remained constant. For most of these, an adjustment to the machine was all that was necessary to render the best operating conditions. The one that was found of

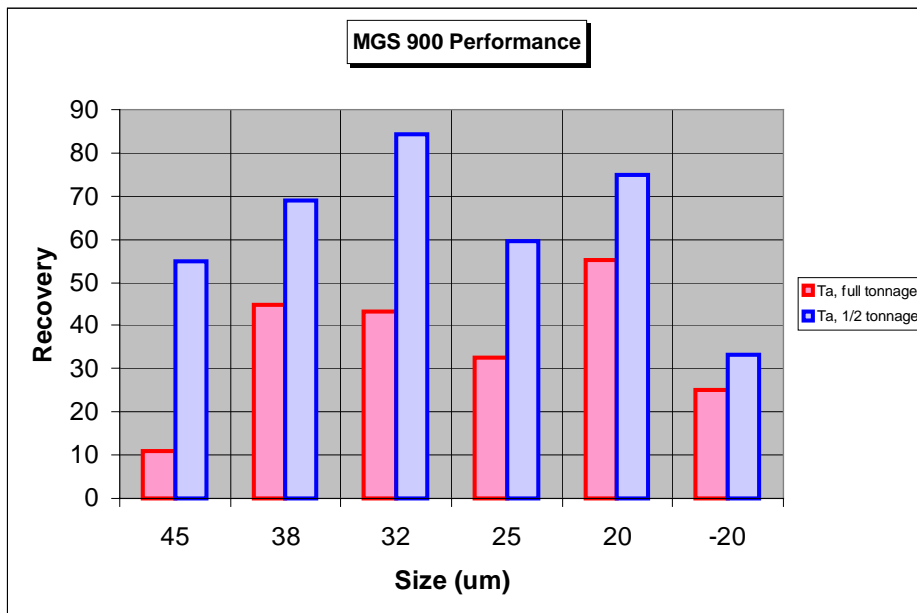

Figure 6. MGS 900 performance at full and at 1/2 tonnage.

Exploratory tests continued with the MGS 900 in order to establish the correct setting for some of its operating parameters. Among those

most interest was that the overall performance of the MGS 900 improved when the tonnage was cut in half even though the weight recovery to concentrate was unchanged. From this, it was

concluded that even if the MGS 900 was fed the rated tonnage, the fine nature of the material created a need for a larger concentrating area in order to have a more efficient separation.

When the flotation circuit was installed at Tanco, it replaced a circuit which consisted of a Mozley MGS 902 along with three cross belts. The MGS 902, which is a double drum centrifugal concentrator capable of treating up to



Figure 7. Mozley MGS 902 at Tanco.

approximately 3.0 mt/hr, served as a rougher, while the cross belt concentrators served as cleaners and recleaners. The MGS 902 can be seen in Figure 7. These idle pieces of equipment were designed to specifically treat very fine

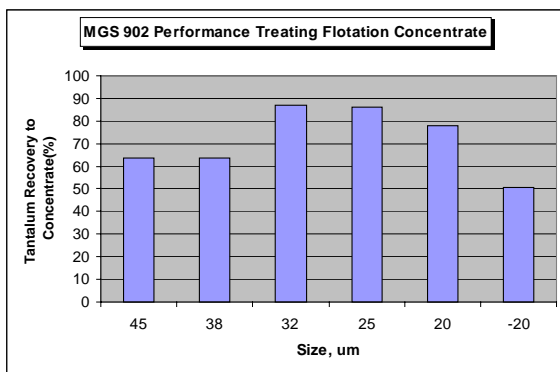

Figure 8. MGS 902 performance treating tantalum flotation concentrate

particles as the ones which required to be recovered.

The availability of this type of equipment coupled with a low tonnage to treat provided

Tanco with a unique advantage in being able to study the effects of different circuit configurations with minimal efforts. The MGS 902 would also provide the additional concentrating area required for such fine particles of tantalum.

One of the two drums from the MGS 902 was returned to service to treat flotation concentrate. Figure 8 shows that treating the flotation concentrate with the MGS 902 allowed us to have improved recovery over the MGS 900 performance due to the larger concentrating area available.

The demand for an acceptable final concentrate necessitated that the MGS 900 should be kept as a cleaner for the MGS 902 concentrate. With a few minor piping changes, the MGS 900 tailings were returned to the MGS 902 to close that portion of the circuit.

The combination of the MGS 902 and MGS 900 yielded a tantalum recovery of approximately 44% from the 2" Mozley cyclone underflow.

It is also important to note that as we were being challenged to solve metallurgical problems, the MGS 900 was experiencing mechanical problems. The design of the MGS 900 was one geared for lab use. The MGS 900 was now a piece of equipment which was required to run on a 24 hr per day in a harsh mill environment. Main bearing and belt failures were not uncommon. Again, Tanco had advantages with extensive knowledge of the mechanical aspects of MGS technology due to the fact that they had been servicing the MGS 902 since 1996. It was noticed that the design of the MGS 900 placed the drum in a cantilever type arrangement with large stresses being generated on the main bearing. The MGS 902, unlike the MGS 900, has a shaft passing through the drum and is supported at both ends. This removes cantilever type forces on the support bearings. With its innovative skills, the mechanical department at Tanco introduced the same type of design for the MGS 900. The shaft was extended through the drum and an arm was constructed complete with bearings to provide support for the extended shaft. This drastically improved the availability of the MGS 900. Figure 9 shows the modifications implemented at Tanco. Studies were completed on parameter settings for both machines. It was found that

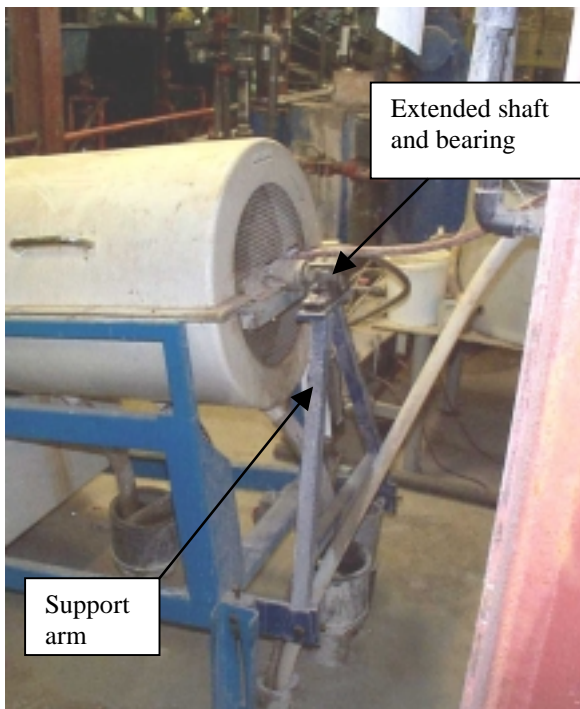

Figure 9. Modifications implemented on the Mozley MGS 900 at Tanco.

determine the type of losses which were being experienced. It was found that the mean particle size of tantalum in the MGS 902 tailings was 6 μm . It was also found that even though complete liberation was low, much of the tantalum contained only minor inclusions of silicates. The tailings were dominated by silicate minerals including phyllosilicates(micas).

This information proved very valuable in the initiation of the changes which made slight improvements to the efficiency of the circuit. The size of the tantalum rejected by the MGS 902 and MGS 900 indicated that the practical limit of the equipment had probably been exceeded with respect to size recovery. The mention of high concentration of micas was also of great interest. With centrifugal separators, particles of small diameter are separated from particles of larger diameter due to a difference in the specific gravity. In this case, we have particles which are relatively close in size (>50 μm) therefore the separation should be easy. By introducing mica to a centrifugal concentrator, this may have provided a material which prevents fine tantalum particles from

even when conditions were set to be optimal,

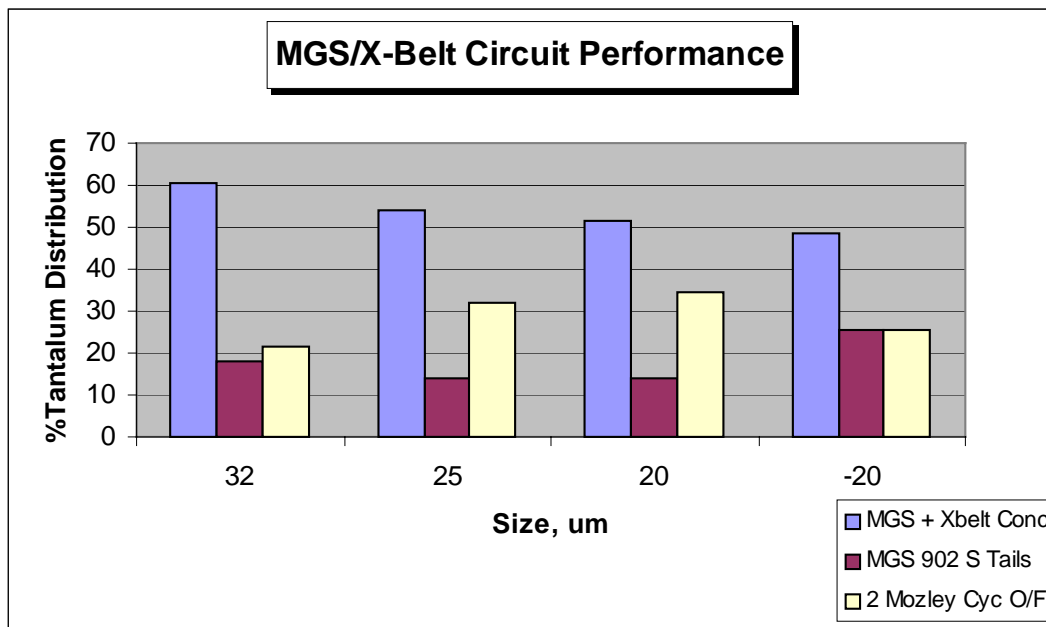

Figure 11. Distribution of tantalum in products from tantalum flotation gravity circuit

significant losses were still being experienced to MGS 902 tailings.

It was decided that a QemScan¹ should be completed on the MGS tailings in order to

attaining the surface of the concentrator and hence being moved by the forces present at the surface of the drum. The fine tantalum particles may in fact be pinning the mica to the surface of

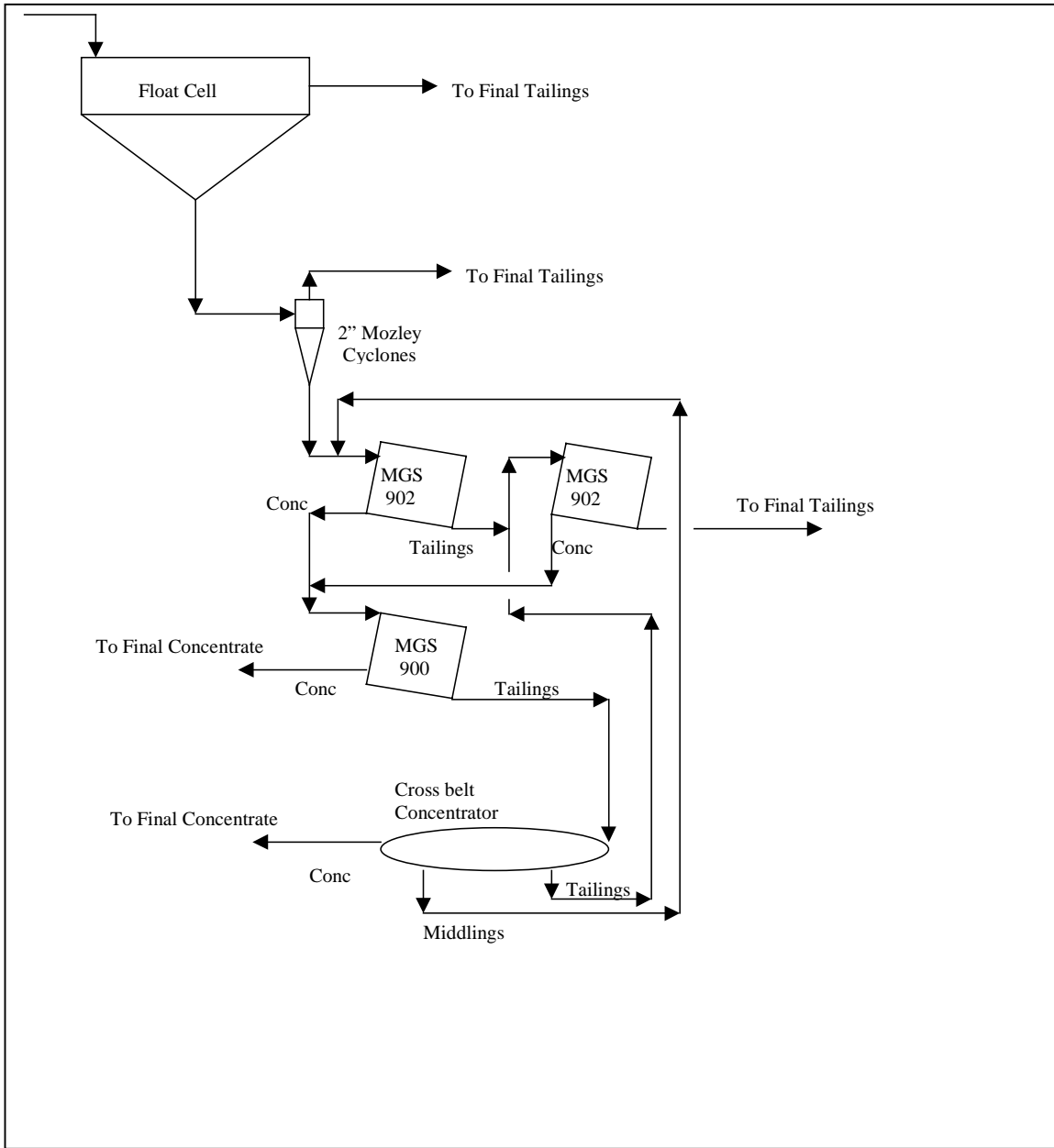

Figure 10. Tantalum flotation concentrate gravity circuit configuration.

the concentrator not unlike a fridge magnet pinning down a sheet of paper.

To combat this effect, it was decided that the MGS 900 tailings should be treated by the cross belt which was idly standing by prior to returning the material to the MGS 902. The cross belt is a flowing film concentrator which would allow the tantalum to find its way past the lighter micas to the surface of the concentrating deck. The lighter mica particle would flow off to the sides of the concentrator as reject aided by some wash-water. The second drum from the

MGS 902 was also reactivated as a scavenger for the cross belt tailings and the reject from the first MGS 902 drum (treating fresh flotation concentrate). This last change definitely improved the overall gravity circuit treating the tantalum flotation concentrate. The circuit configuration can be seen in Figure 10.

Figure 11 illustrates the distribution of tantalum leaving the gravity circuit which treats tantalum flotation concentrate. This circuit recovers, on average, just over 50% of the

tantalum and produces a concentrate of approximately 5.0 %Ta₂O₅.

New technology or old?

Dissatisfied with the losses incurred from the MGS tailings and the 2" Mozley cyclones, alternative types of concentrators were investigated. It is known that the MGS concentrators generate much lower g forces than equipment such as the Falcon concentrators. Having extensive experience with the Falcon continuous concentrators, Falcon Concentrators Inc of British Columbia Canada was contacted in search of a simple machine, which would generate very high gravitational forces. These could possibly efficiently recover such fine tantalum. Steve McAlister of Falcon Concentrators Inc indicated that there existed a technology which had initially been developed but had never truly been embraced by the commercial world of

stream was selected since it contained tantalum which could be recovered with the MGS/cross belt unlike the tantalum in the MGS 902 tailings stream. With a feed density of 24%, 80% of the tantalum was recovered with 32% of the weight reporting to concentrate. After a few more tests with the MGS 902 tails, 75% tantalum recovery was obtained with a weight recovery to concentrate of 11% and a feed density of 8%. The enrichment ratio for this test was 6.38

Noticing that the performance of the machine was superior when treating lower density MGS 902 tailings, additional tests were completed on the 2" Mozley cyclone underflow at lower densities. The performance improved as the density dropped. From this information, it was concluded that tests should be completed on the 2" Mozley cyclone feed (a.k.a. flotation concentrate). In a single pass test, we attained results exceeding

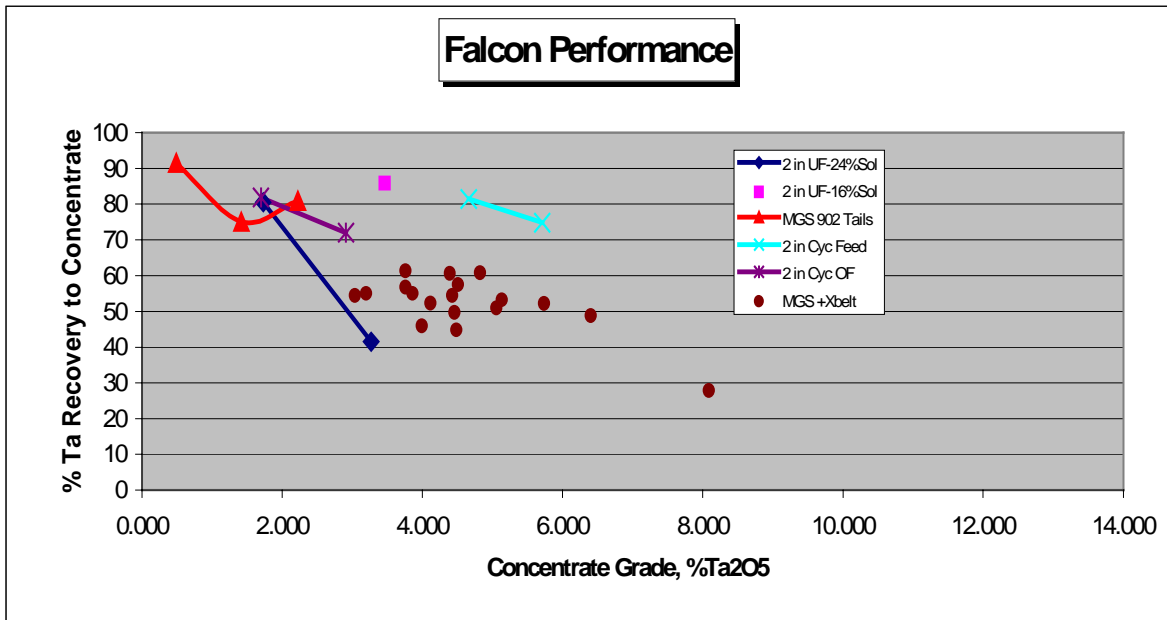

Figure 12. Falcon performance on various streams versus MGS/cross belt circuit.

mineral processing.

The initial goal for the tests with this machine would be to determine if tantalum could be recovered from the MGS 902 tailings. This concentrator was set to generate over 350 g's.

Results from the first trial showed data which had the potential of leading to great things. The initial test was completed on 2" Mozley cyclone underflow (a.k.a. – MGS/cross belt feed). This

that of the entire gravity circuit treating the flotation concentrate. With a feed density of 3%, tantalum recovery to concentrate was 81.50% with 21.64% of the weight reporting to concentrate. The enrichment ratio for this test was 5.47

In order to see if the results could be duplicated on another low-density stream containing very fine tantalum, the 2" Mozley cyclone overflow was tested. Similar results were attained. Figure 12 shows the results attained with the concentrator

along with performance data from the MGS/cross belt circuit.

From these results, it was concluded that any further tests should be completed on the flotation concentrate (gravity circuit feed) and not on MGS 902 tails since there existed the possibility of removing 2" Mozley cyclones from the circuit. With the Falcon's ability to treat low density feed,

multi-stage circuit can be configured using a single machine with the help of surge tanks. Even though this may not be practical in large-scale operations, it is very useful in pilot-scale applications when studying the effects of multiple stage operations. Based on single pass test results, the pilot circuit was configured so that there was a rougher stage, a scavenger stage treating rougher tails and a cleaner stage treating rougher and scavenger stage

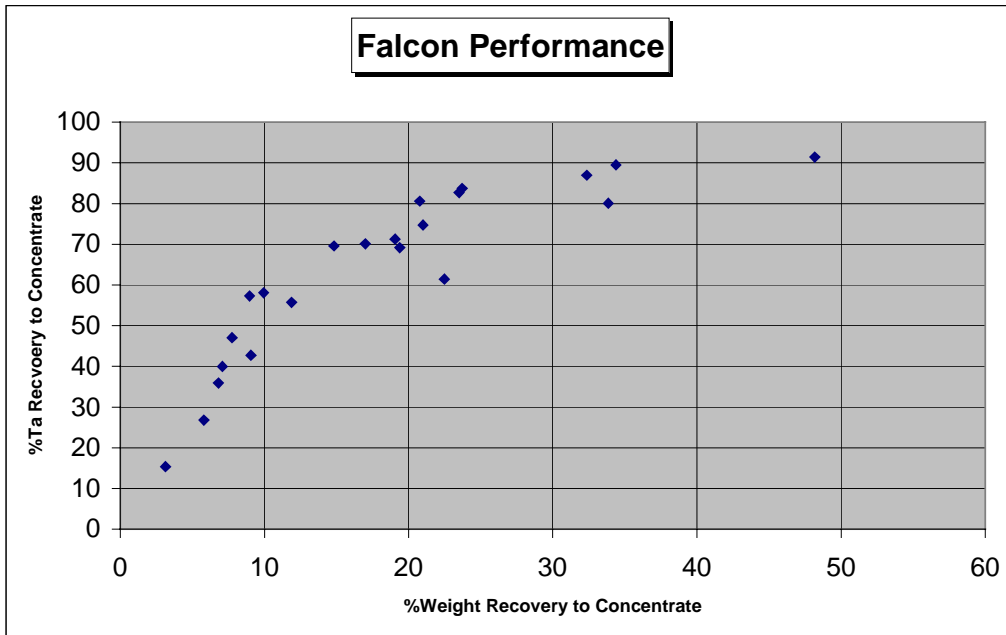

Figure 13. Falcon test unit weight recovery versus tantalum recovery.

the cyclones would not be required for dewatering. This would eliminate one of the circuit's sources of losses. More tests were completed in order to determine equipment capacity along with relationships such as weight recovery versus tantalum recovery to concentrate. It was determined that the unit which had a 6" diameter bowl, was capable of treating up to 25 kg/hr before performance began to deteriorate. A relationship between weight recovery and tantalum recovery to concentrate was established. Recovery results were highly predictable when weight recovery was known providing that feed tonnage was kept within the capacity previously determined. The relationship of weight recovery versus tantalum recovery to concentrate can be seen in Figure 13.

Unlike the MGS and the cross belt, this type of Falcon is a batch unit requiring no washwater addition for the separation of particles. Water is however required for the rinse cycle when material is removed from the bowl. With a batch unit, a

concentrate. A cleaner scavenger stage was added to help simulate the effect of returning the cleaner tailings to the head of the circuit. For the rougher stage, a weight recovery of 20% was targeted since it was known from previously established trends that tantalum recovery would be in the area of 80%. For the scavenger stage, a 10% weight recovery was targeted. A total of nearly 90% of the tantalum was recovered as concentrate by the rougher and scavenger stage with an enrichment ratio of 2.6. This material was then treated by the cleaner stage. The overall tantalum recovery and enrichment ratio based on an open circuit cleaner stage were 75% and 5.5 respectively. The cleaner scavenger stage showed that over 70% of the tantalum could be recovered with just under 30% weight recovery. This indicated that the overall recovery of 75% could no doubt be improved in a circuit where the cleaner circuit was closed. Size analysis was completed on all the products from the pilot test. Figure 14 shows the distribution of tantalum for each stream. From these, it can

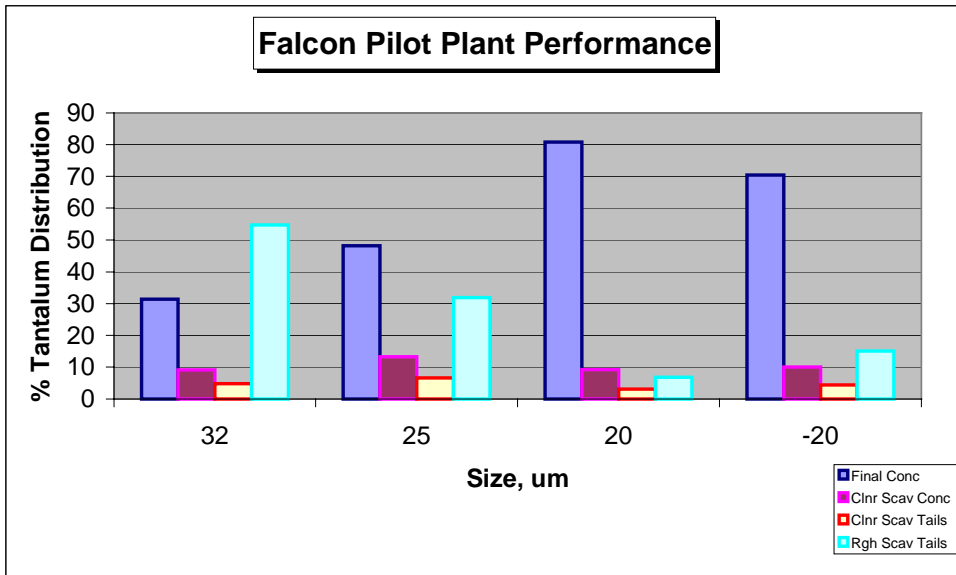

Figure 14. Tantalum distribution in products from pilot with high-g Falcon concentrator

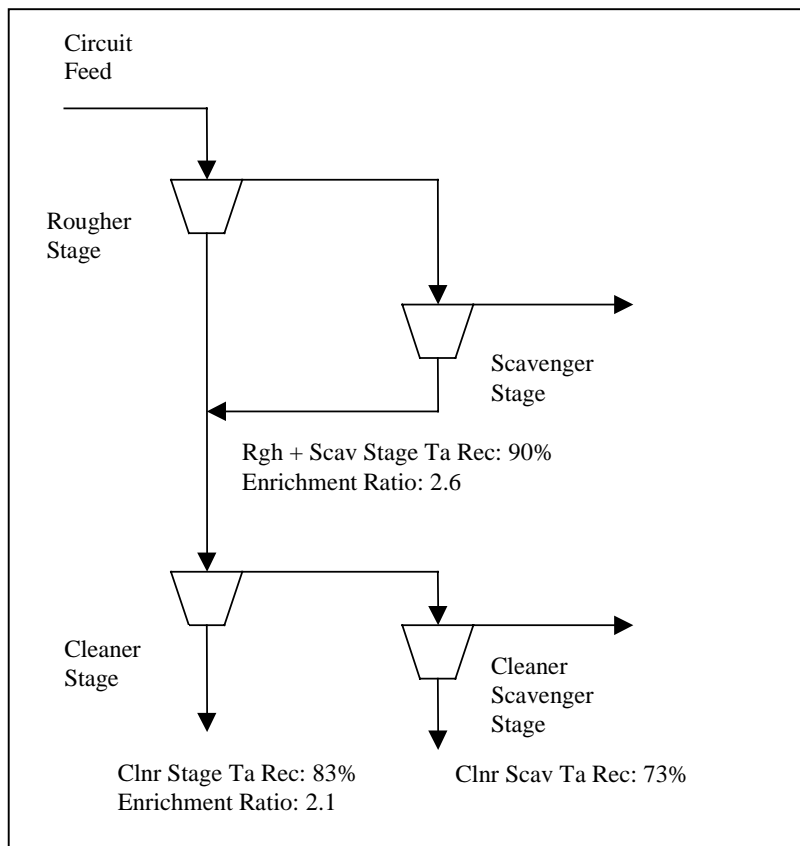

Figure 15. Pilot test flow diagram with Falcon concentrator.

clearly be see that tantalum recovery in fine fractions has greatly been improved from results attained with the MGS + cross belt circuit. Figure 15 shows the pilot circuit as tested.

Conclusions

From the tests completed with a lab scale high g-force Falcon concentrator, it can be concluded that the successful implementation of this technology will no doubt improve the overall

performance of plants which rely on gravity concentration. It has clearly been shown that finer tantalum can be recovered with this technology than with any other equipment currently operating in Tanco's plant.

Please note that, as this paper was being written, modifications were made to the design of the Falcon which generated results superior to those discussed in the report. Tantalum recoveries of up to 86% were attained with weight recoveries to concentrate as low as 17% from a single pass test. This new development delayed verification of the lab and pilot scale tests along with the implementation of the technology at full scale.

Copyright 2004 Tantalum Mining Corporation of Canada, Ltd. All rights reserved.

References

1. SGS Lakefield Research Limited,
"QemSCAN Analysis of Tantalum Department
in MGS902 Tailing", 8901-214 MI6001-Jun03